



# **Quad Pod K50 / K65 - MK5**

## **Rapid Deployment Mobile Lighting System**

### **Spare Parts Manual**



# **SPARES - CATEGORIES**

**A - Light Head Assembly**

**B - Mast Assembly**

**C - Handle Assembly**

**D - Cover Assembly**

**E - Control Box Assembly**

**F - Wheel Assembly**

**G - Stabiliser Leg Assembly**

**H - Base Assembly**

# MAIN MAST

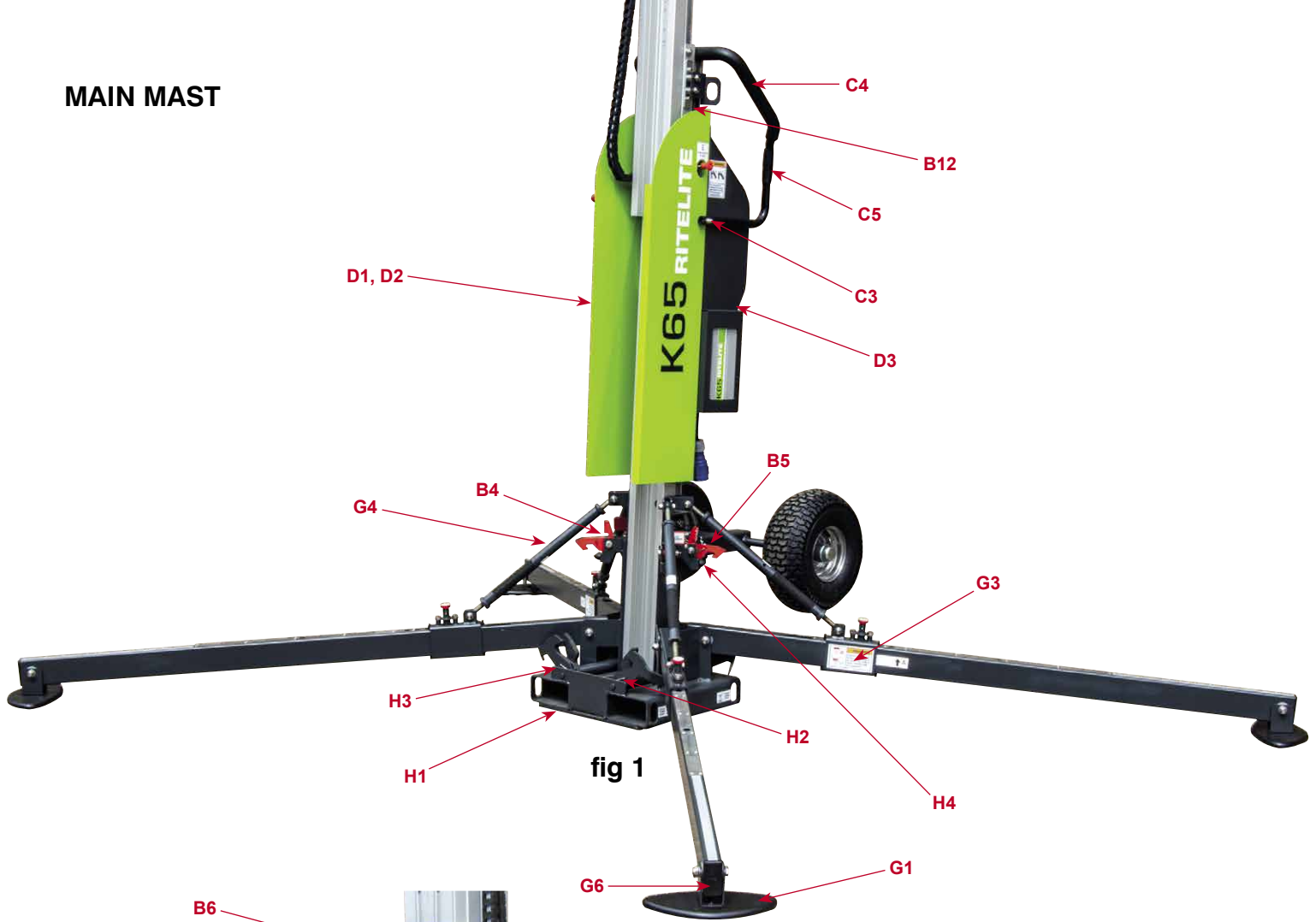

fig 1

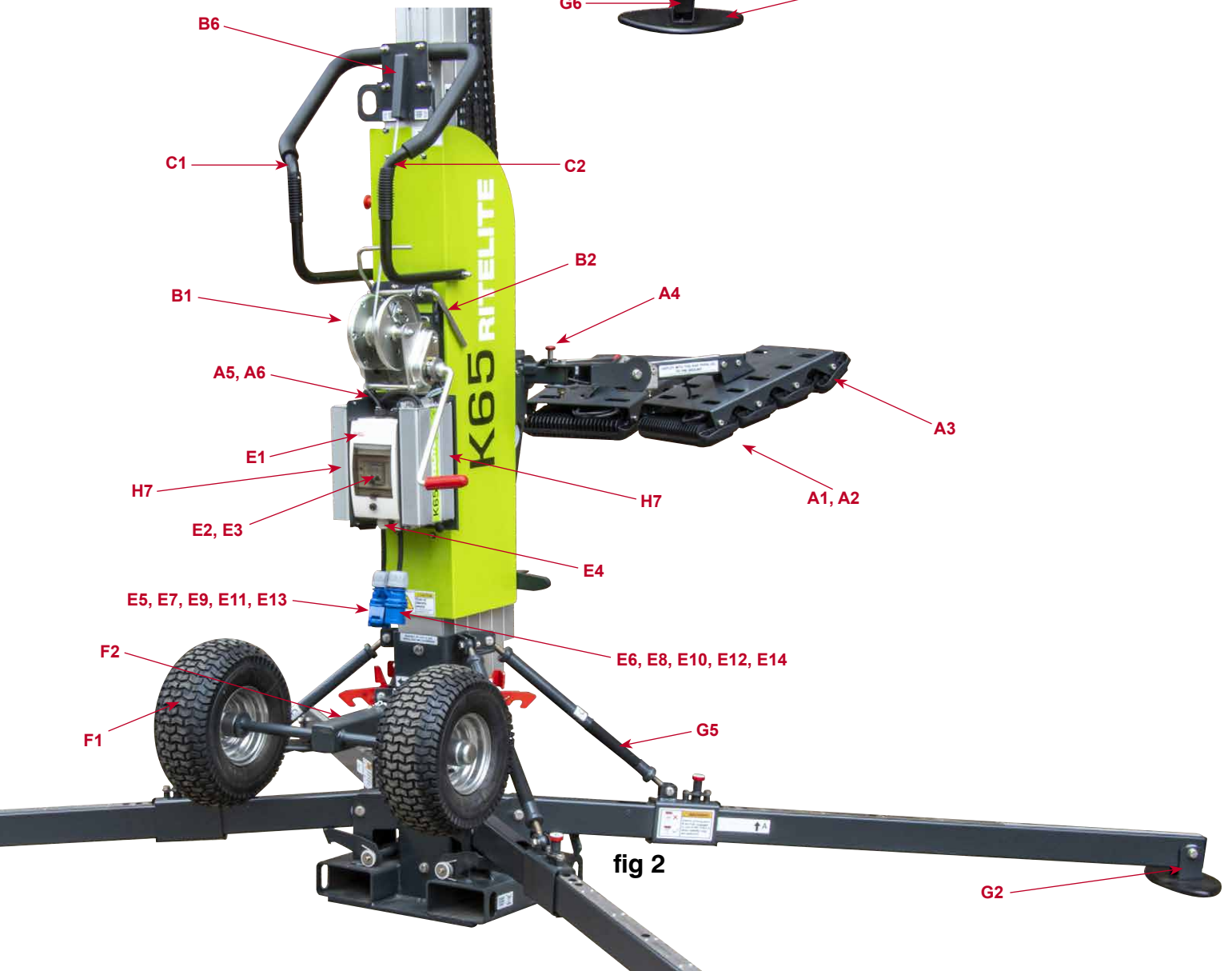
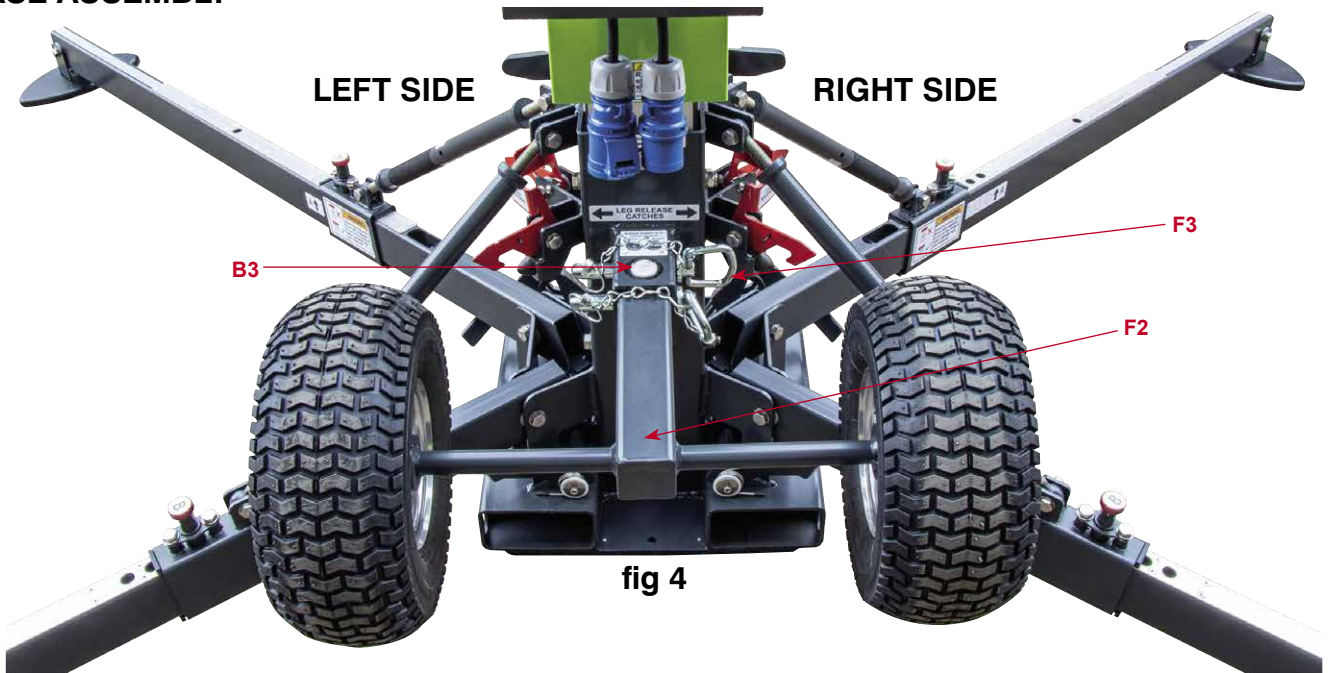

fig 2

**LED LIGHT HEADS**



**BASE ASSEMBLY**



**STABILITY LEG INTERLOCK SPRING SET LOCATIONS**

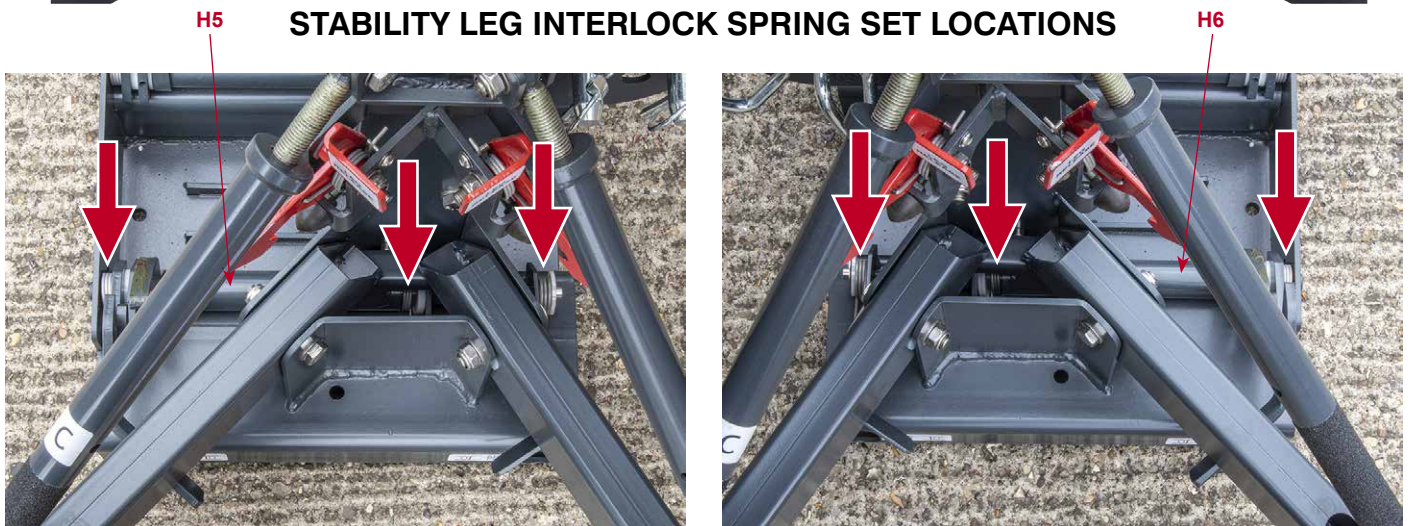



**H2 LEFT HAND SPRINGS**

**fig 5**

**H3 RIGHT HAND SPRINGS**

## A - LIGHT HEAD ASSEMBLY

REF	K50	K65	PRODUCT CODE	DESCRIPTION	IMAGE
A1	Y	Y	QP-12WAYL	QUAD POD 12 WAY LIGHT MODULE	
A2	Y	Y	QP-9WAYL	QUAD POD 9 WAY LIGHT MODULE	
A3	Y	Y	2000847	75W 6500K IP66 130 X 25 BEAM ANGLE	
A4	Y	Y	2000112	MODEL 07 IP 7MM (PIN) M12 X 1.75MM 8MM PLUNGER MALE THREAD	
A5	Y	Y	2000900	EC100 BLACK 2 POLE FEMALE IP68 10A 910021503 6.5MM SEAL	
A6	Y	Y	2000898	EC100 BLACK 2 POLE MALE PLUG IP68 10A 910021403 6.5MM SEAL	
A7	Y	Y	2000919	2 WAY CONNECTOR LOOM	

REF	K50	K65	PRODUCT CODE	DESCRIPTION	IMAGE
A8	Y	Y	2000920	3 WAY CONNECTOR LOOM	
A9	Y	Y	2000921	4 WAY CONNECTOR LOOM	





## B - MAST ASSEMBLY

REF	K50	K65	PRODUCT CODE	DESCRIPTION	IMAGE
B1	Y	Y	K50/K65-02	WINCH FOR MULTI-WIRE MAST	
B2	Y	Y	2000115	QP WIRE TENSIONING DEVICE	
B3	Y	Y	K50/K65-99	CIRCULAR SPIRIT LEVEL	
B4	Y	Y	QP-104	K50/K65 LEG CATCH LH (MK4 / 5)	

REF	K50	K65	PRODUCT CODE	DESCRIPTION	IMAGE
B5	Y	Y	QP-105	K50/K65 LEG CATCH RH (MK4 / 5)	
B6	Y	Y	QP-119	K50/K65 LIFTING BRACKET (MK4 / 5)	
B7	Y	Y	2000285	CABLE TRACK BRACKET (MK3 / 4 / 5)	
B8	Y	Y	QP-113	K65 TRANSIT STOP LH (MK3 / 4 / 5)	
B9	Y	Y	QP-114	K65 TRANSIT STOP RH (MK3 / 4 / 5)	
B10	Y		QP-125	K50 TRANSIT STOP LH (MK3 / 4 / 5)	
B11	Y		QP-126	K50 TRANSIT STOP RH (MK3 / 4 / 5)	

REF	K50	K65	PRODUCT CODE	DESCRIPTION	IMAGE
B12	Y	Y	QP-118	K50/K65 PIN RELEASE LEVER (MK4 / 5)	

### C - HANDLE ASSEMBLY

REF	K50	K65	PRODUCT CODE	DESCRIPTION	IMAGE
C1	Y	Y	2000118	QP HANDLE LH SIDE COMPLETE	
C2	Y	Y	2000119	QP HANDLE RH SIDE COMPLETE	
C3	Y	Y	2000239	QP MK3 / 4 / 5 HANDLE STUDDING S/S (278MM)	
C4	Y	Y	K50/K65-30	FOAM HANDLE GRIP	
C5	Y	Y	K50/K65-35	HANDLE GRIPS	



## D - COVER ASSEMBLY

REF	K50	K65	PRODUCT CODE	DESCRIPTION	IMAGE
D1	Y		QP-100	K50 MAIN COVER GREEN (MK4 / 5)	
D2		Y	QP-101	K65 MAIN COVER GREEN (MK4 / 5)	
D3	Y	Y	QP-33-02	K50/K65 WINCH COVER (MK5)	



## E - CONTROL BOX ASSEMBLY

REF	K50	K65	PRODUCT CODE	DESCRIPTION	IMAGE
E1	Y	Y	K50/K65-05	CONTROL BOX	
E2	Y	Y	K50/K65-06C	RCBO 6KA, 30MA, C CURVE 1 POLE + N, 16 AMP, 230VAC	
E3	Y	Y	K50/K65-06D	RCBO 6KA, 30MA, C CURVE 1 POLE + N, 16 AMP, 110VAC	

REF	K50	K65	PRODUCT CODE	DESCRIPTION	IMAGE
E4	Y	Y	2000120	20MM CABLE GLAND WHITE	
E5	Y	Y	BS16/240C	BS4343 16AMP 3PIN 240V COUPLER	
E6	Y	Y	BS16/240P	BS4343 16 AMP 3 PIN 240V PLUG	
E7	Y	Y	BS16/110C	BS4343 16AMP 3PIN 110V COUPLER	
E8	Y	Y	BS16/110P	BS4343 16 AMP 3 PIN 110V PLUG	
E9	Y	Y	BS16/240C/IP67	240V 16A 3PIN COUPLER IP67	
E10	Y	Y	BS16/240P/IP67	240V 16A 3PIN PLUG IP67	

REF	K50	K65	PRODUCT CODE	DESCRIPTION	IMAGE
E11	Y	Y	BS16/110C/IP67	110V 16A 3PIN COUPLER IP67	
E12	Y	Y	BS16/110P/IP67	110V 16A 3PIN PLUG IP67	
E13	Y	Y	2001046	240V EURO SCHUKO SOCKET (TYPE F)	
E14	Y	Y	2000654	240V EURO SCHUKO PLUG (TYPE F)	

## F - WHEEL ASSEMBLY

REF	K50	K65	PRODUCT CODE	DESCRIPTION	IMAGE
F1	Y	Y	K50/K65-16	K50/K65 WHEEL (13" X 6" 25MM AXLE)	
F2	Y	Y	QP-106	K50/K65 WHEEL AXLE (MK4 / 5)	

## F - WHEEL ASSEMBLY





REF	K50	K65	PRODUCT CODE	DESCRIPTION	IMAGE
F3	Y	Y	K50/K65-17	LOCATING PIN 19 X 99	



## G - STABILISER LEG ASSEMBLY

REF	K50	K65	PRODUCT CODE	DESCRIPTION	IMAGE
G1	Y	Y	K50/K65-19	'STYLED' FOOT PLATE	
G2	Y	Y	K50/K65-32F	FOOT MOUNTING 'U' BRACKET	
G3	Y	Y	QP-27-12	QP MK5 - LEG - SLIDE BOX	
G4	Y	Y	QP-23-00	QP TIE BAR ASSEMBLY	
G5	Y	Y	2000066	TIE BAR GRIP TAPE	

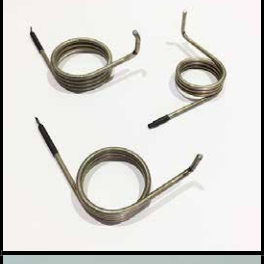
REF	K50	K65	PRODUCT CODE	DESCRIPTION	IMAGE
G6	Y	Y	K50/K65-97	RECTANGULAR BUNG	

## H - BASE ASSEMBLY

REF	K50	K65	PRODUCT CODE	DESCRIPTION	IMAGE
H1		Y	2000762	K50/K65 BASE PLATE POLYPROPENE STAB PINSEAL BLACK	
H2	Y	Y	2000316	STABILITY LEG INTERLOCK SPRING SET (3 SPRINGS) LH (see fig 5)	
H3	Y	Y	2000317	STABILITY LEG INTERLOCK SPRING SET (3 SPRINGS) RH (see fig 5)	
H4	Y	Y	2000240	M8 CONICAL BUFFER (25D X 20H)	
H5	Y	Y	QP-121	K50/K65 INTERLOCK CAM SHAFT LH (MK4 / 5)	

REF	K50	K65	PRODUCT CODE	DESCRIPTION	IMAGE
H6	Y	Y	QP-122	K50/K65 INTERLOCK CAM SHAFT RH (MK4 / 5)	
H7	Y	Y	K45-07/QP	LED DRIVER 600W 7.4A (QP SPEC)	

The contents of this manual are subject to change without prior notice. We take no responsibility for errors or admissions.

**Ritelite (Systems) Ltd**  
Meadow Park, Bourne Road, Essendine, Stamford, Lincolnshire, PE9 4LT  
Tel. (01780) 758585 E-mail. [sales@ritelite.co.uk](mailto:sales@ritelite.co.uk)  
[www.ritelite.co.uk](http://www.ritelite.co.uk)